

# BF09221152

**LED FLEX STRIP**

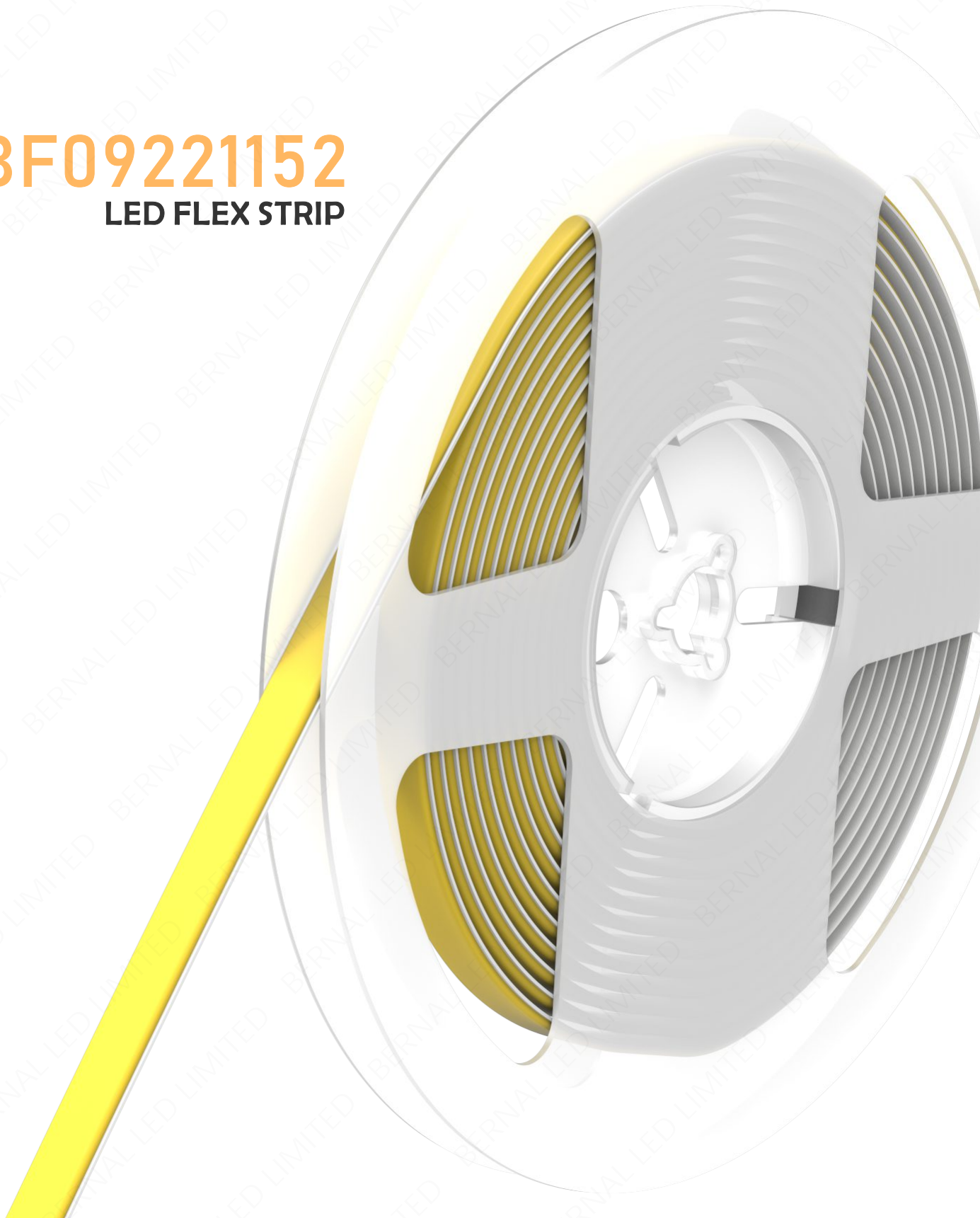

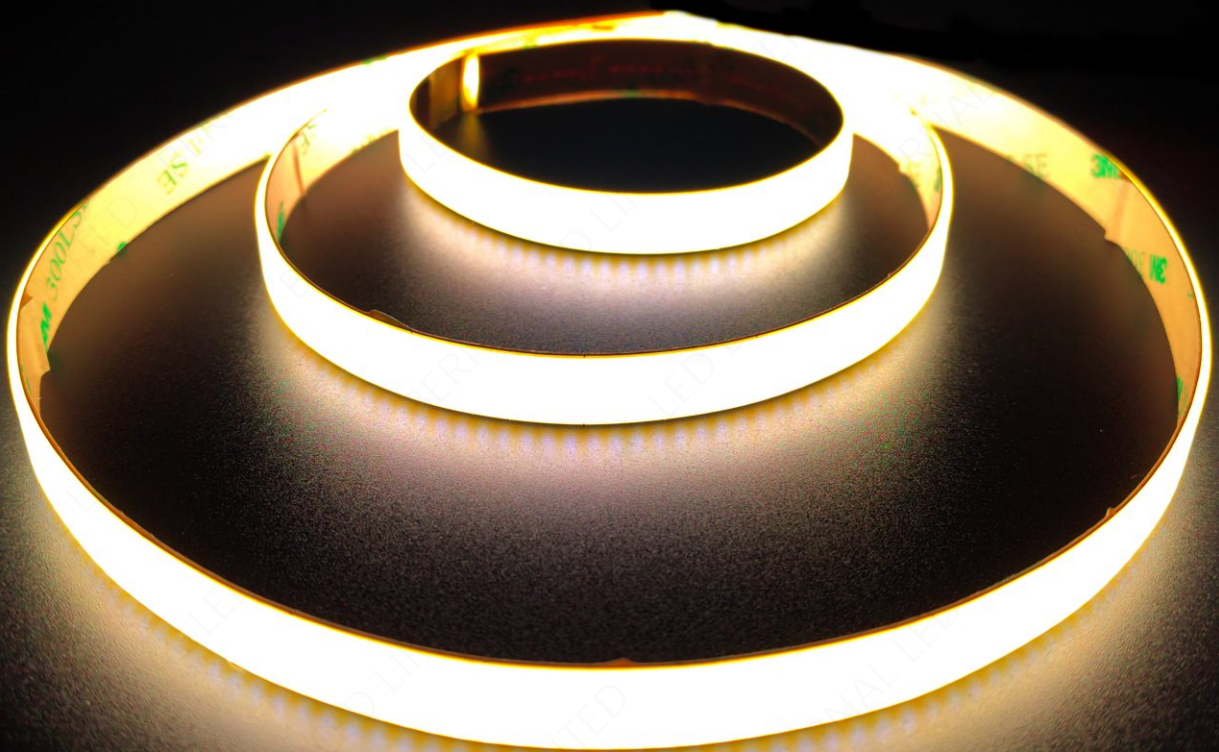

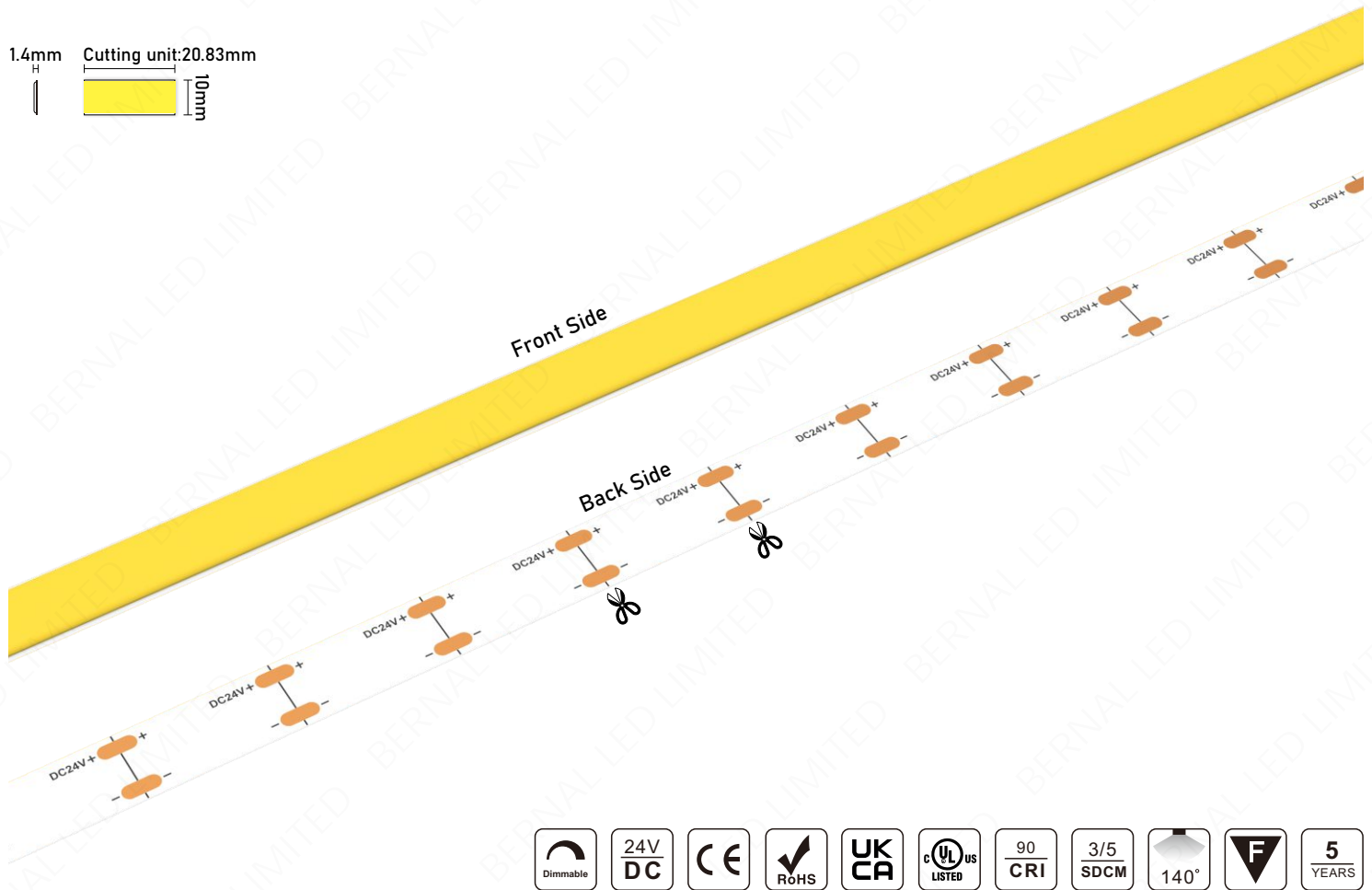
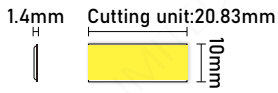

This product is based on our most popular High Quality SAN'AN LED CHIP. This version offers an excellent combination of high light output with a strong color to provide outstanding results. Available in all primary colors to cover most requirements. Supplied in 24V DC as standard for more accurate cut lengths. Bin control for LED color to ensure consistent color throughout all off your orders.

## PRODUCT FEATURE & BENEFITS

- ◆ Always using double-layer FPCB, mounted with high quality led Chips
- ◆ Low power requirement & Energy Efficient
- ◆ High color rendering RA > 90
- ◆ High-performance FPCB & LED for extremely long life
- ◆ Available in IP20 rating
- ◆ Great design freedom thanks to flexibility and cuttability of module
- ◆ Easy mounting on many smooth surfaces thanks to self-adhesive tape at the back

## PRODUCT CODE

BF	0922	1152	L2	90	S	S	2	65	20
0922 - COB LED	1152 - 1152 LEDs/m	L2 - 24V DC	90 - RA>90	S - SAN'AN LED	S - PCB Width 10mm	2 - PCB 2OZ	65 - 6500K 40 - 4000K 30 - 3000K 27 - 2700K RE - Red GR - Green BL - Blue	20 - IP20	

## TECHNICAL DATA

LED Brand	SAN'AN LED
Normal Voltage	24V DC
Normal Current per Meter	0.6A
Rated Wattage per Meter <sup>Ⓞ</sup>	14.4W/m
Type of Current	Direct Current / Constant Voltage
Light Color <sup>Ⓞ</sup>	6500K / 4000K / 3000K / 2700K / R / G / B
Luminous Flux per Meter <sup>Ⓞ</sup>	1865 lm
Luminous Efficacy <sup>Ⓞ</sup>	128 lm/W
Color Rendering Index / RA	RA>90
Length per Smallest Cutting Unit	20.83mm
LED Number per Smallest Cutting Unit	24 LED Chips
Length per roll for package	5 meters / 10 meters
Width of Printed Circuit Board	10mm
Color of Printed Circuit Board	White
Thickness of Printed Circuit Board	2 OZ
Double Side Adhesive Tape	3M
Temperature Range in Operation	-20°C ... 70°C
Temperature Range at Storage	-20°C ... 50°C
Dimmable	Yes
Type of Protection	IP20
Life Span	> 50000 Hours

\* Ⓞ Max. power < 15.8W

\* Ⓞ Customized color available

\* Ⓞ Tested @4000K RA>90

\* Ⓞ Tested @4000K RA>90

\* Testing environment temperature: 25±2°C

\* The actual data of each single product may differ from above typical data which are subject to change without prior notice.

## COLOR RENDERING INDEX (CRI)

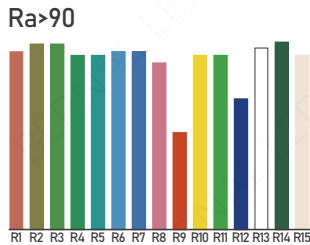
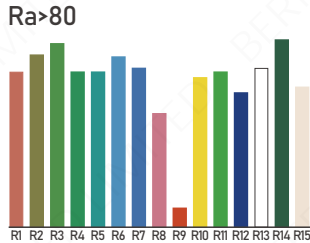

Ra evaluation index is applied to estimate the color rendering index of the lighting product to see the reflection level on natural color compared to those by conventional lighting.

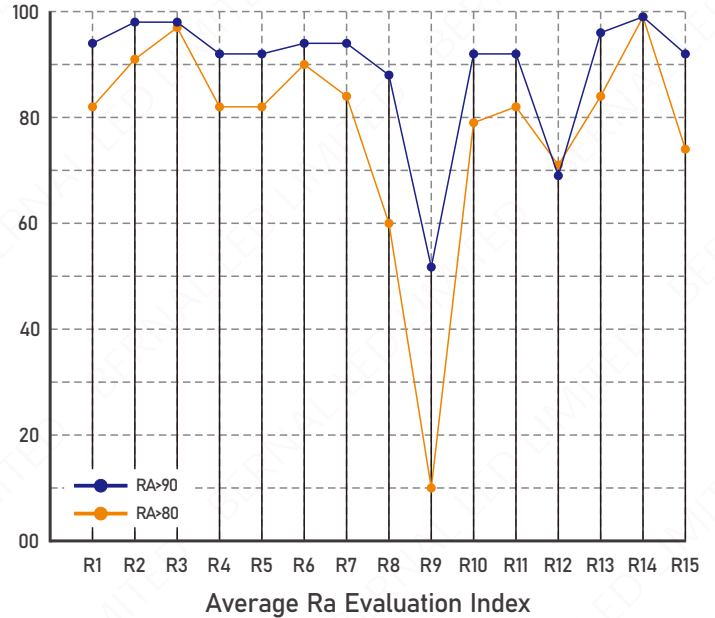

\* The actual data of each single product may differ from above typical data which are subject to change without prior notice.

## COLOR BIN DEFINITION

Spectroscopic standard complies with CIE 1931(Cx, Cy). The SDCM is less than 3-step to ensure customers to get the same color even for different orders.

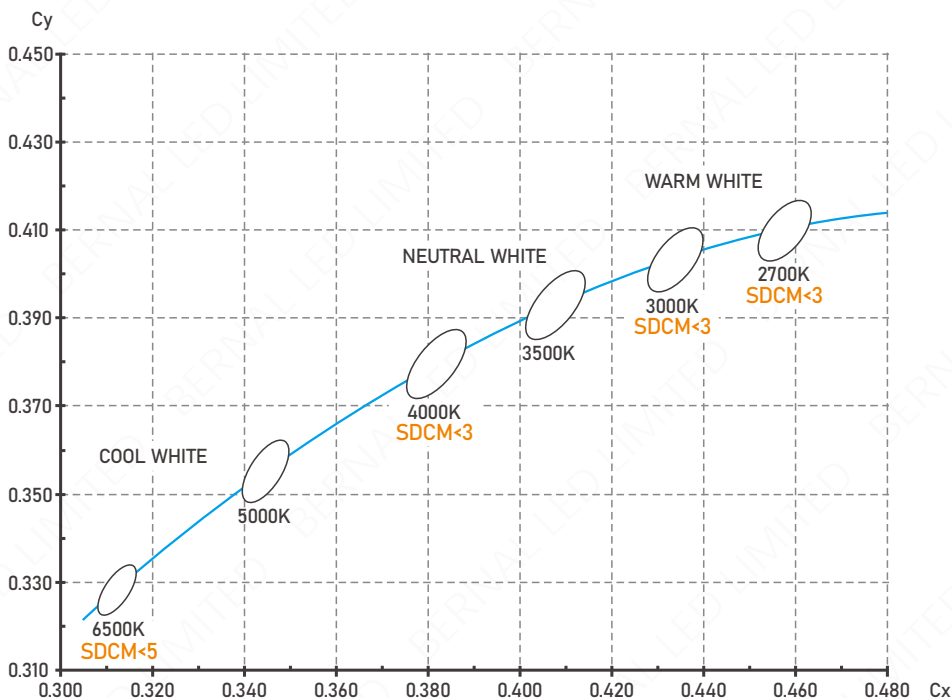

## CONNECTION SYSTEM

### - Typical ON/OFF System

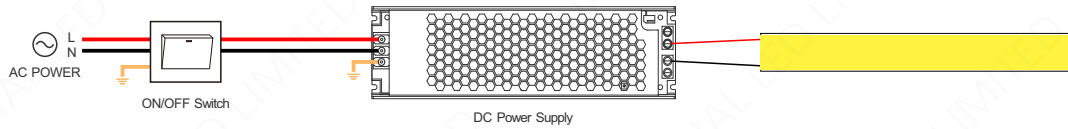

### - Basic DIM System

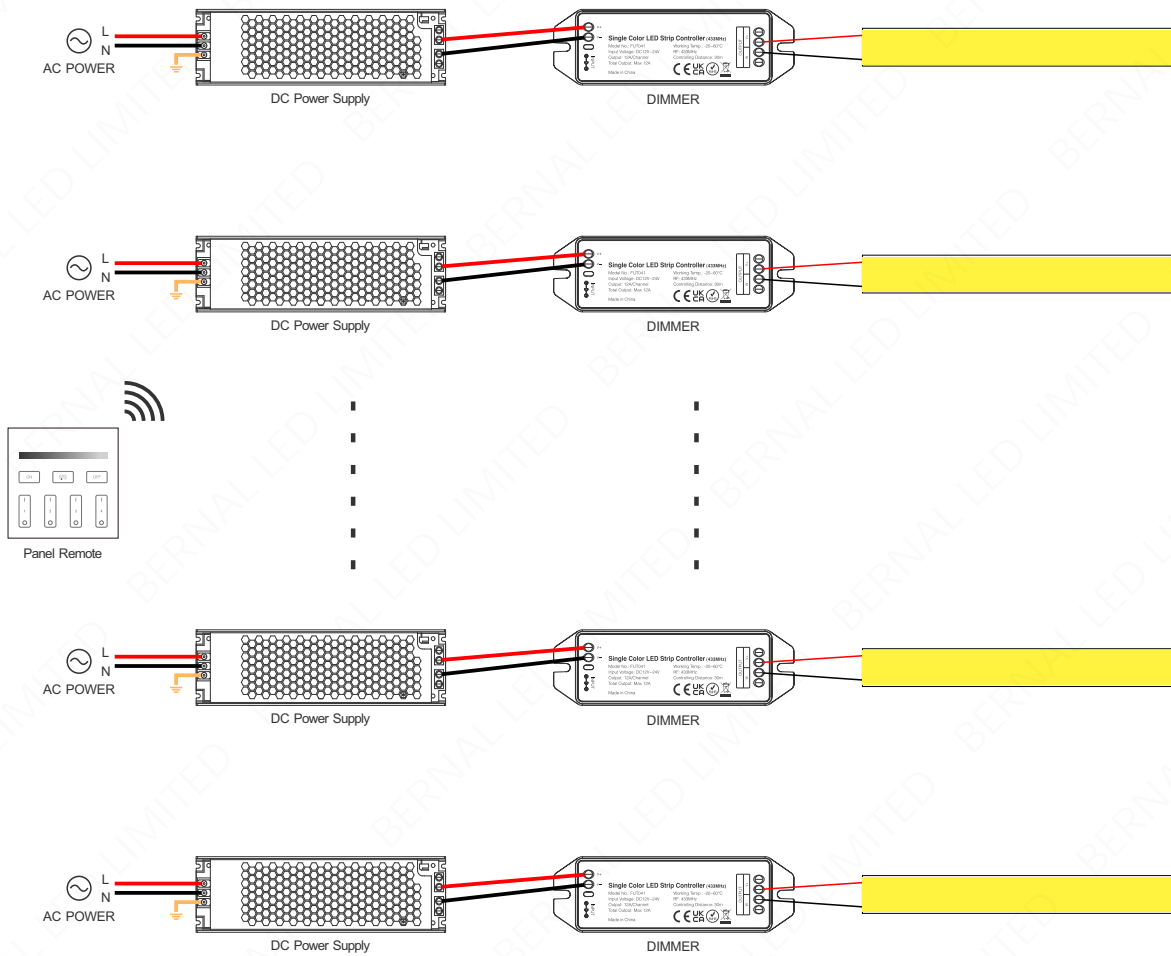

The dimmer can transmit the signals from the remote control to another dimmer within 30 meters. As long as there is a dimmer within 30 meters, the remote control distance can be limitless.

## CONNECTION SYSTEM

### - DALI DIM SYSTEM

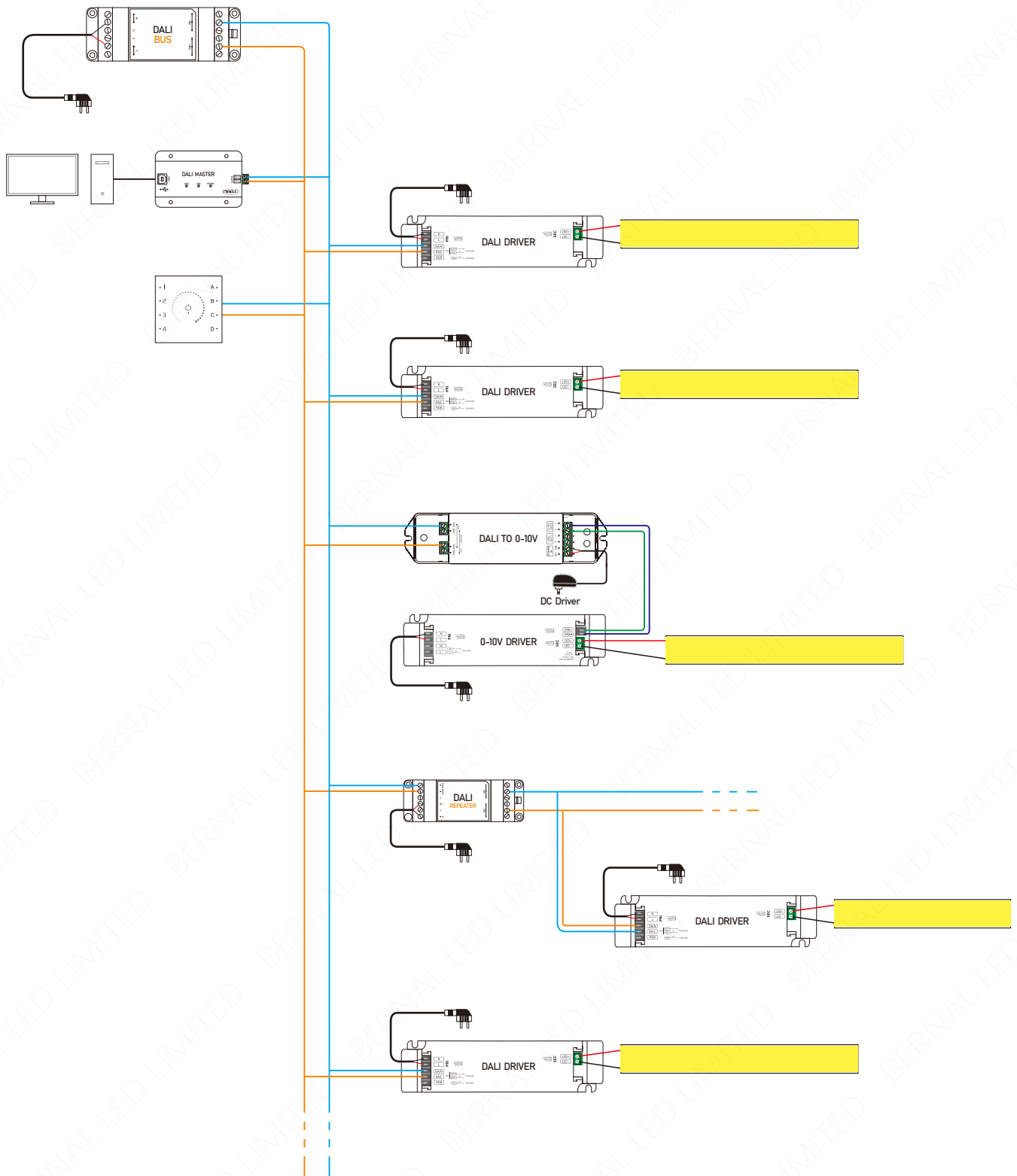

## NOTES ON HANDLING

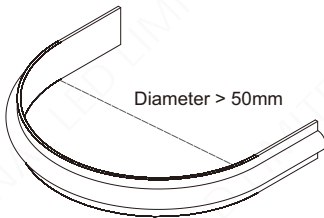

**DO NOT** bend LED strip to a diameter less than 50mm.

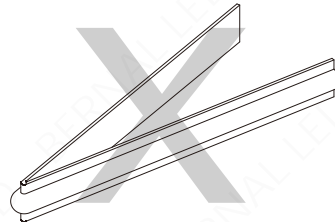

**DO NOT** fold or crease LED strip

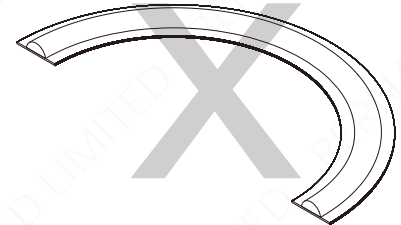

**DO NOT** bend LED strip on a horizontal plane

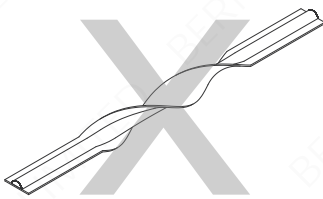

**DO NOT** over twist LED strip

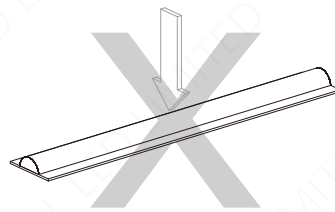

**DO NOT** put excessive pressure on surface of LED

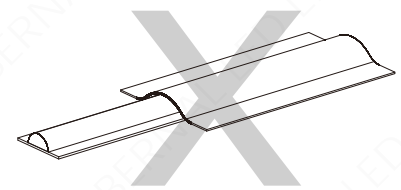

**DO NOT** cover LED strip with any materials

## INSTALLATION INSTRUCTIONS

1. The mounting surface must be clean, dry and free from dust or grease.
2. Release the LED strip from the package and unreel.
3. Measure and cut the LED strip to the required length (only cut at the cut marks with power OFF).
4. Remove the 3M self-adhesive backing tape from the strip gradually during installation.  
**DO NOT** remove it all at once to avoid the strip becoming entangled and sticking to itself.
5. Stick the LED strip to the mounting surface by pressing on the strip in between components only.  
**DO NOT** press on the LEDs or other components on the strip.
6. You can use optional mounting clips to secure the strips at intervals.
7. Once the strip is affixed, it is then ready to be wired.

 **CAUTION** - Twisting, pressing on LEDs, over-bending the strip, cutting at non-cut points, incorrectly powering the strip or exposing a standard strip (IP20) to water, particles or direct sunlight will invalidate the warranty.

## SAFTY

---

1. Installation must be in accordance with local and national electrical code regulations.
2. To ensure safety and correct installation, our strips are intended to be installed by a licensed electrician.
3. Only install with a Constant Voltage LED driver.
4. Each maximum run requires a dedicated power feed from the driver.  
**DO NOT** extend beyond the recommended maximum run length.
5. Make sure the appropriate gauge wire is installed between driver, LEDs, and any dimmers. When choosing wire, calculate voltage drop, maximum amperage rating, and the location ratings on the wire. Improper wire selection and installation could overheat wires and cause fire.
6. **DO NOT** modify product beyond instructions or warranty will be void.



Questions? Please contact us via [info@bernal-led.com](mailto:info@bernal-led.com)