

BPS101301

ALUMINUM PROFILE

10x13mm Anodized Treatment

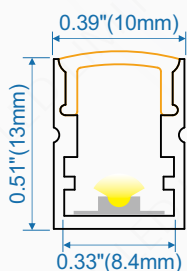

ALUMINUM PROFILE

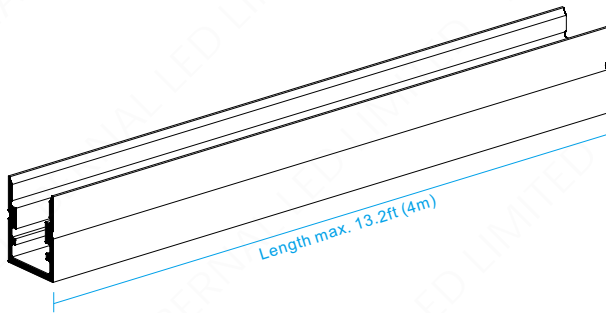

- ◆ Using High Quality 6063-T5 Aluminum as a material
- ◆ High Standard of anodizing aluminum surface
- ◆ International Standard Anodized Silver Color
- ◆ Heat Sink and physical protection to the LEDs
- ◆ Suitable for Max. 8mm width LED flexible strips
- ◆ Available length 1m, 2m, 2.5m, 3m, 4m

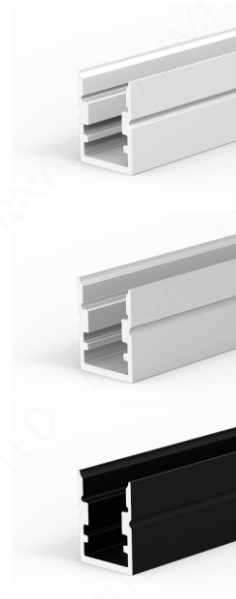

- White Painted
- Silver Anodized
+ standard color
- Black Anodized

DIFFUSER

The milky color diffusers are capable of transmitting a large spread of the LED light. It is able to give a uniform brightness and is used as a cover for LED lights to eliminate or reduce the light points of the LEDs.

Color	Milky
Material	PC
Working Temperature	-50°C ~ 100°C
Light Transmission	86%
Coefficient Diffusion	Medium
Method of Assembly	Push in

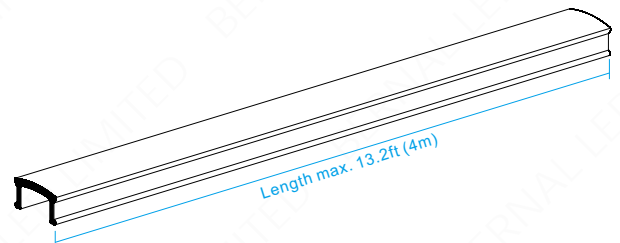

- Color:**
- 1.Transparent
 - 2.Milky (opal)
+ standard color
 - 3.Black

HOW TO INSTALL THE PROFILE?

Way 1:

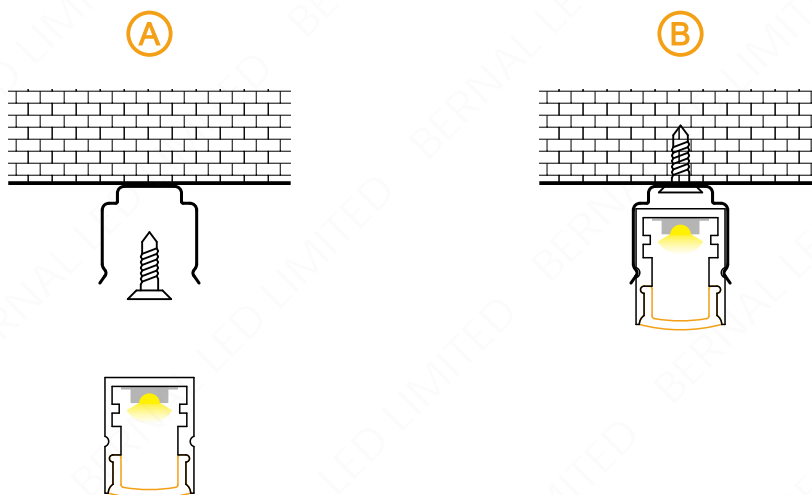

Way 2:

